

Article number: 2030100M850A2S

Description: E+G levelling foot

GN 30-100-M8-50-A2-S

Note: S Withoutnut, External hexagon at the bottom

## Measures

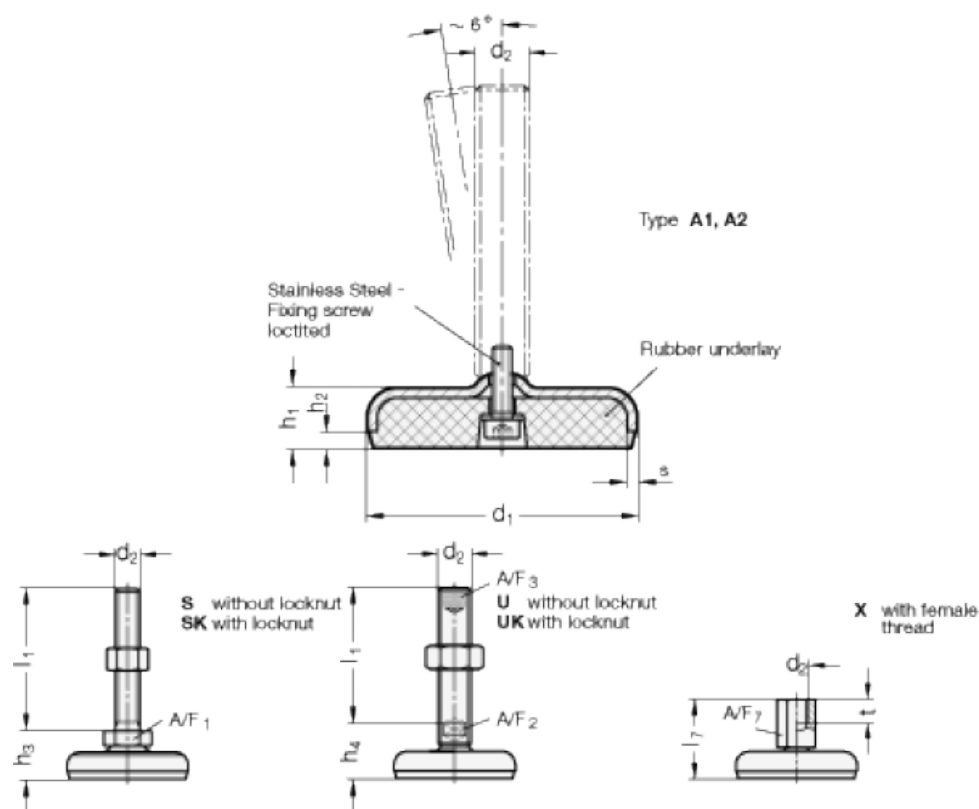

A/F1	=	17
d1	=	100
d2	=	M8
h1	=	20
h2	=	6
h3	=	28
l1	=	50
s	=	3